



For FAQs and more information, please visit:

www.eufylife.com

51005001225 V03



Health & Wellness

Owner's Manual

Smart Scale C1
Smart Scale C1
Báscula Inteligente C1
Balance Intelligente C1
Bilancia Smart C1

Bedienungsanleitung | Manual del usuario
Manuel d'utilisation | Guida di Utilizzo

01 English

07 Deutsche

13 Español

19 Français

25 Italiano

What's In the Box

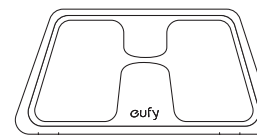

Smart Scale C1

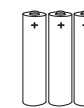

AAA Battery (x3)

Owner's Manual &
Quick Start Guide

Inserting the Batteries

- 1 Turn the scale over and place it on a flat surface.
- 2 Open the battery door and insert three AAA batteries. Make sure the positive and negative ends are facing the correct polarity directions marked in the battery compartment.
 - The digits "0000" will show on the LED display.
- 3 Close the battery door and wait until the digits "000" are shown on the LED display.

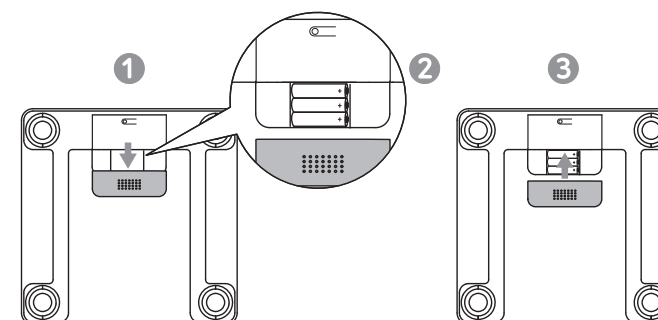

LO will appear on the LED display when the batteries are low. Replace all three batteries at the same time. Do not mix new and used batteries.

Selecting the Measuring Unit

Press the **UNIT** button at the bottom of the scale to cycle through and select the measuring unit: **lb** (Pound) / **kg** (Kilogram). The measuring unit can be selected from within the EufyLife app as well.

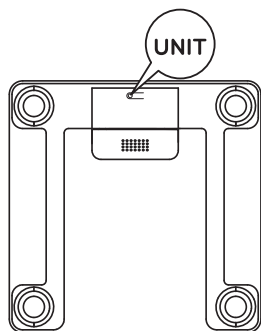

Installing the EufyLife App and Pairing

- 1 Download the EufyLife app from the App Store (iOS devices) or Google Play (Android devices).
- 2 Enable Bluetooth on your smartphone or tablet.
- 3 Open the EufyLife app and follow the on-screen instructions to pair the scale with your device.
 - Once paired, the app and scale will automatically connect the next time the app is opened.

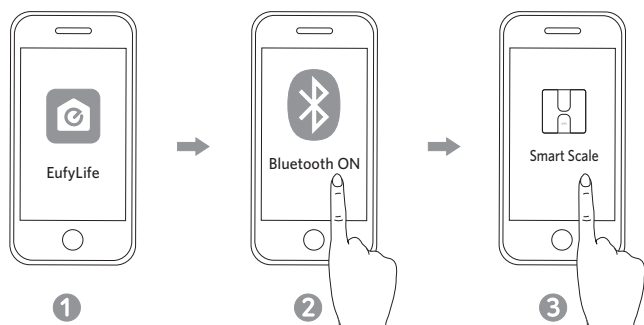

	Status Icon	Indicates
	Flashing	Pairing
	Solid	Connected



- This scale is compatible with devices running iOS 8.0 and above or Android 4.3 and above.
- Do not pair the scale from your smartphone's Bluetooth menu. Use the EufyLife app to pair the scale with your smartphone.

Starting a Measurement

Before taking your first measurement, you will need to create and set up a user ID in the EufyLife app. It is possible to create up to 16 user IDs.

- 1 Place the scale on a hard and flat surface.
- 2 Open the EufyLife app and select Smart Scale on the device homepage.
- 3 Step barefoot onto the scale. An analysis of your body's composition will begin automatically.



Step on the center of the scale barefoot. Stand still and keep full contact with the electrodes until the measurement is complete.

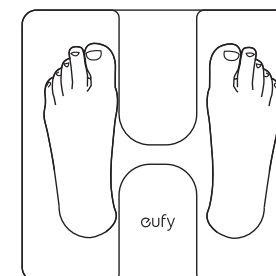

Weight-Only Measurement

This scale can also be used as a conventional weight-reading scale. You can simply step on the scale to measure your current weight without opening the EufyLife app.

Maintenance

Regularly clean the scale with a dry or slightly dampened soft cloth.



- Do not wash the scale with water or immerse it in water.
- Never use detergents to clean the scale as this may cause it to malfunction or discolor.

Troubleshooting

Error Message

Error Display	Description	Solution
OL	Overload. The device will power off.	Stop using this scale for measurement.
Lo	Low battery. The device will power off.	Replace all three batteries at the same time.
Err	Measurement failure.	<ul style="list-style-type: none"> • Step barefoot and keep full contact with the electrodes. • Stand still until the measurement on the LED display locks.

When Measuring

Issue	Cause	Solution
Abnormal measurement results: <ul style="list-style-type: none"> • Too high • Too low • Huge difference between two recent measurements 	<ul style="list-style-type: none"> • Incorrect posture. • Device is placed on soft carpeting or uneven surface. 	<ul style="list-style-type: none"> Step onto the scale barefoot and stand still. Place the device on a hard and flat surface.
LED display does not turn on after stepping onto the scale.	<ul style="list-style-type: none"> • Batteries not installed. • Worn batteries. 	<ul style="list-style-type: none"> • Install three new batteries. • Replace all three batteries at the same time.
Scale does not proceed to analyse body composition.	<ul style="list-style-type: none"> • Taking a measurement while wearing shoes or socks. 	<ul style="list-style-type: none"> • Stand barefoot on the scale and keep feet in full contact with the electrodes when taking a measurement.

Specifications

Product Model	T9146
Power Source	4.5 V (3 × AAA batteries)
LED Display	67 × 29 mm / 2.6 × 1.2 in
Measurement Unitse	Pound / Kilogram
Unit Increments	0.1 lb / 0.1 kg
Body Fat Unit Increments	0.1 %
Body Water Unit Increments	0.1 %
Muscle Mass Unit Increments	0.1 %
Measurement Range	11-397 lb / 5-180 kg
Working Environment	Temperature: 5 - 40 °C Humidity: 20 - 90% RH
Storage Environment	Temperature: -20 - 50 °C Humidity: <= 90% RH
Operating Frequency Range	2402 - 2480 MHz
Radio-Frequency Power	4 dBm
Dimension	280 × 280 × 23 mm / 11.0 × 11.0 × 0.9 in
Net Weight	3.31 lb / 1.5 kg

Customer Service

 15-month limited warranty

 Lifetime technical support

 support@eufylife.com

 (US) +1 (800) 988 7973 Mon - Fri 9:00am - 5:00pm (PT)
 (UK) +44 (0) 1604 936200 Mon - Fri 6:00 - 11:00 (GMT)
 (DE) +49 (0) 69 9579 7960 Mo - Fr 6:00 - 11:00
 (中国) +86 400 0550 036 周一至周五 9:00 - 17:30
 (日本) +81 03 4455 7823 月 - 金 9:00 - 17:00

 @EufyOfficial

 @EufyOfficial

 @EufyOfficial

 @EufyOfficial

AUSTRALIA & NEW ZEALAND WARRANTY

This document details the terms and conditions of the warranty provided with this product. Please disregard any other representations contained on this product's packaging or provided with this product, which constitute or appear to constitute a warranty.

Subject to the exclusions and limitations set out below, we warrant to you that if you purchase a product directly from us, or, from any of our authorized resellers, that it will not contain defects which are a result of faulty manufacturer workmanship or materials. This warranty subsists for 15 months from the date of purchase. This warranty is provided in addition to your rights under the Australian & New Zealand Consumer Law.

Subject to any rights you have under the Australian & New Zealand Consumer Law, we will not be liable for defects which are a result of damage or loss caused by factors beyond our control, any product which has not been maintained according to any care or maintenance instructions provided with the product, any alterations to a product which are not performed by us, or damage or defects caused to the product due to unusual or non-recommended use. We will not be liable for any special, indirect, consequential or economic loss or damage or loss of profits whatsoever suffered by you or any other person resulting from any act or omission by us. Our total liability in respect of this Warranty against Defects is limited to the replacement of the goods.

This Warranty against Defects is provided in addition to other rights and remedies that you may have at law. Our goods come with guarantees that cannot be excluded under the Australian Consumer Law. You are entitled to a replacement or refund for a major failure and for compensation for any reasonably foreseeable loss or damage. You are also entitled to have the goods repaired or replaced if the goods fail to be of acceptable quality and the failure does not amount to a major failure.

In order to claim the warranty, you must return the product to the retailer from which it was purchased or if that retailer is part of a National network, a store within that chain, along with satisfactory proof of purchase. The retailer will then return the goods to Directed Electronics Australia authorized by Anker Innovations Limited. Directed Electronics Australia will repair, replace or refurbish the product at its discretion. The retailer will contact you when the product is ready for collection. All costs involved in claiming this warranty, including the cost of the retailer sending the product to Directed Electronics Australia, will be borne by you.

This warranty is offered by Directed Electronics Australia.
 Customer service support number (+61) 3 8331 4800 Mon-Fri 8:30am - 5:00pm (AEST) and
 customer service email address support@myanker.com.au.

Was ist im Lieferumfang

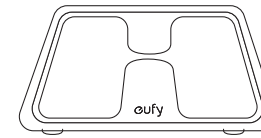

Smart Scale C1



AAA Battery (x3)

Gebrauchsanweisung
und Kurzanleitung

Einlegen der Batterien

- 1 Drehen Sie die Waage um und legen Sie sie auf eine ebene Fläche.
- 2 Öffnen Sie die Batteriefachabdeckung, und legen Sie drei AAA-Batterien ein. Vergewissern Sie sich, dass die positiven und negativen Enden den korrekten Polaritätsrichtungen, die im Batteriefach angegeben sind, entsprechen.
- Die Ziffern „8888“ werden auf der LED-Anzeige angezeigt.
- 3 Schließen Sie das Batteriefach und warten Sie, bis die Ziffern „00“ auf der LED-Anzeige angezeigt werden.

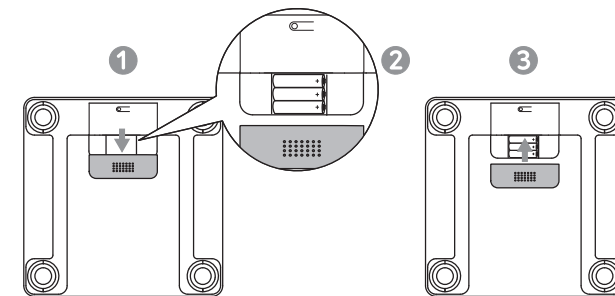

 Wenn die Batterien fast leer sind, erscheint **LO** auf der LED-Anzeige. Tauschen Sie alle drei Batterien gleichzeitig aus. Kombinieren Sie nie neue und gebrauchte Batterien.

Auswahl der Messeinheit

Drücken Sie die **Unit**-Taste an der Unterseite der Waage, um zwischen den Messeinheiten zu wechseln und die Messeinheit zu wählen: **lb** (Pfund) / **kg** (Kilogramm). Die Messeinheit kann auch innerhalb der App ausgewählt werden.

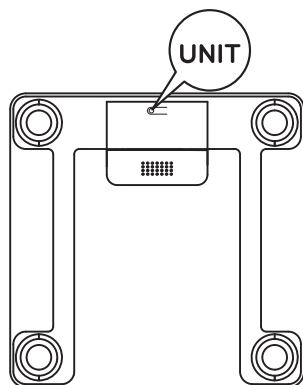

Installieren der EufyLife App und Pairing

- 1 Laden Sie die EufyLife App aus dem App Store (iOS Geräte) oder Google Play (Android Geräte) herunter.
- 2 Aktivieren Sie Bluetooth auf Ihrem Smartphone oder Tablet.
- 3 Öffnen Sie die EufyLife App und folgen Sie den Anweisungen der App, um die Waage mit Ihrem Gerät zu koppeln.

- Wenn Sie Ihr Gerät mit der Waage gepairt haben, verbindet sich die Waage, sobald Sie die App öffnen, automatisch bei der nächsten Anwendung.

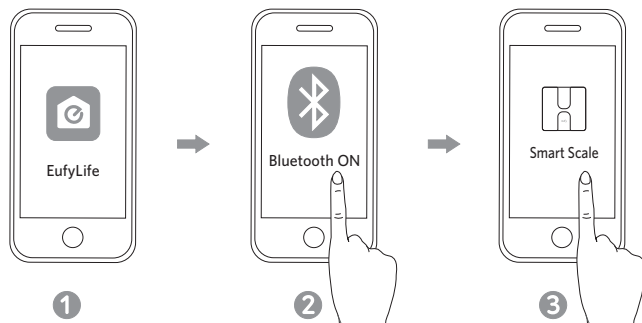

	Status-Symbol	Zeigt an	
		Blinkt	Pairing
		Durchgehend leuchtend	Verbunden



- Diese Waage ist mit den Betriebssystemen iOS 8.0 und Android 4.3 und höher kompatibel.
- Pairen Sie die Waage nicht über das Bluetooth-Menü Ihres Smartphones. Verwenden Sie die EufyLife App, um die Waage mit Ihrem Smartphone zu verbinden.

Starten einer Messung

Bevor Sie Ihre erste Messung durchführen, müssen Sie eine Benutzer-ID in der EufyLife App erstellen und einrichten. Es können bis zu 16 Benutzer-IDs erstellt werden.

- 1 Stellen Sie die Waage auf einer harten und flachen Oberfläche auf.
- 2 Öffnen Sie die EufyLife App und wählen Sie Smart Scale auf der Gerätehomepage.
- 3 Treten Sie barfuß auf die Plattform der Waage. Eine Analyse der Zusammensetzung Ihres Körpers beginnt automatisch.



Treten Sie barfuß auf die Mitte der Waage. Stehen Sie still und halten Sie den Kontakt mit den Elektroden, bis die Messung abgeschlossen ist.

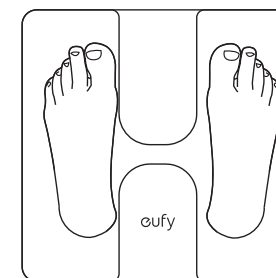

Nur-Gewicht-Messung

Diese Waage kann auch als konventionelle Gewichtswaage verwendet werden. Sie können einfach auf die Waage treten, um Ihr aktuelles Gewicht zu messen, ohne die EufyLife App zu öffnen.

Instandhaltung

Reinigen Sie die Waage regelmäßig mit einem trockenen oder leicht angefeuchteten weichen Tuch.



- Waschen Sie die Waage nicht mit Wasser und tauchen Sie sie nicht in Wasser.
- Verwenden Sie niemals Reinigungsmittel, um die Waage zu reinigen, da dies zu Fehlfunktionen oder Verfärbungen führen kann.

Fehlerbehebung

Fehlermeldung

Fehleranzeige	Beschreibung	Lösung
OL	Überlast. Das Gerät schaltet sich aus.	Beenden Sie die Messung.
Lo	Niedriger Batteriestatus. Das Gerät schaltet sich aus.	Tauschen Sie alle drei Batterien gleichzeitig aus.
Err	Messfehler.	<ul style="list-style-type: none"> • Treten Sie barfuß auf die Waage und halten Sie Kontakt mit den Elektroden. • Stehen Sie still, bis die Messung auf der LED-Anzeige fest angezeigt wird.

Beim Messen

Problem	Ursache	Lösung
Abnormale Messergebnisse: <ul style="list-style-type: none"> • Zu hoch • Zu niedrig • Großer Unterschied zwischen zwei neueren Messungen 	<ul style="list-style-type: none"> • Falsche Haltung. • Gerät ist evtl. auf weichem Teppichboden oder einer unebenen Oberfläche aufgestellt. 	Treten Sie barfuß auf die Waage und stehen Sie still. Stellen Sie das Gerät auf einer harten und flachen Oberfläche auf.
Die LED-Anzeige schaltet sich nicht ein, nachdem Sie auf die Waage getreten sind.	<ul style="list-style-type: none"> • Es sind keine Batterien eingelegt. • Leere Batterien. 	<ul style="list-style-type: none"> • Legen Sie drei neue Batterien ein. • Tauschen Sie alle drei Batterien gleichzeitig aus.
Die Waage beginnt nicht die Körperzusammensetzung zu analysieren.	<ul style="list-style-type: none"> • Wiegen mit Schuhen oder Socken. 	<ul style="list-style-type: none"> • Stellen Sie sich barfuß auf die Waage und halten Sie Ihre Füße während der Messung im vollen Kontakt mit den Elektroden.

Technische Daten

Produktmodell	T9146
Leistung	4,5 V (3 x AAA Batterien)
LED-Anzeige	67 × 29 mm
Messeinheiten	Pfund / Kilogramm
Einheit	0,1 kg
Körperfett	0,1%
Wasseranteil	0,1%
Muskelmasse	0,1%
Messbereich	5-180 kg
Arbeitsumfeld	Temperatur: 5 - 40°C Luftfeuchtigkeit: 20 - 90% RH
Umgebungsbedingungen für die Lagerung	Temperatur: -20 - 50°C Luftfeuchtigkeit: ≤ 90% RH
Betriebsfrequenzbereich	2402 - 2480 MHz
Funkfrequenz	4 dBm
Abmessungen	280 × 280 × 23 mm
Nettogewicht	1,5 kg

Kundenservice

 15 Monate beschränkte Herstellergarantie

 Lebenslanger technischer Support

 support@eufylife.com

 (US) +1 (800) 988 7973 Mon - Fri 9:00am - 5:00pm (PT)
 (UK) +44 (0) 1604 936200 Mon - Fri 6:00 - 11:00 (GMT)
 (DE) +49 (0) 69 9579 7960 Mo - Fr 6:00 - 11:00
 (中国) +86 400 0550 036 周一至周五 9:00 - 17:30
 (日本) +81 03 4455 7823 月 - 金 9:00 - 17:00

 @EufyOfficial

 @EufyOfficial

 @EufyOfficial

Contenidos de la caja

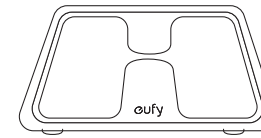

Smart Scale C1



Pilas "AAA" (×3)



Manual del propietario
y Guía de inicio rápido

Colocación de las pilas

- 1 Posicione la báscula boca abajo, en una superficie plana.
- 2 Abra la tapa de las pilas e inserte tres pilas AAA. Asegúrese que las polaridades positivas y negativas concuerden con aquellas indicadas en el compartimiento de pilas.
- Verá los dígitos "8888" en el visor LED.
- 3 Vuelva a colocar la tapa del compartimiento de pilas y espere a que la báscula muestre los dígitos "00" en su visor LED.

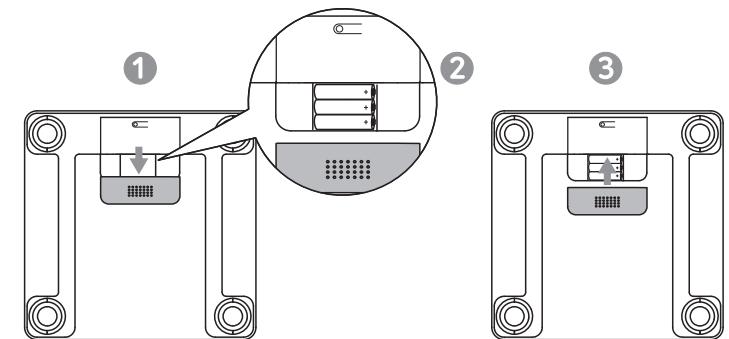

Lo aparecerá en el visor LED cuando las pilas estén por agotarse. Sustituya las tres pilas al mismo tiempo. No mezcle pilas nuevas con pilas usadas..

Selección de unidades de medida

Presione el botón **Unit** que se encuentra bajo la báscula con el fin de mostrar y pasar por las opciones de unidades de medida: **lb** (Libras) / **kg** (Kilogramos). También puede configurar las unidades de medida a utilizar desde su aplicación móvil.

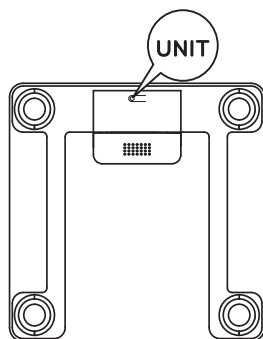

Instalación de la aplicación móvil EufyLife y sincronización de dispositivos

- 1 Descargue la aplicación móvil EufyLife desde la App Store (en dispositivos iOS) o Google Play (en dispositivos Android).
- 2 Active la conexión Bluetooth de su tableta o teléfono inteligente.
- 3 Abra la aplicación móvil EufyLife y siga las instrucciones entregadas para sincronizar sus dispositivos.
 - Tras sincronizar los dispositivos, la aplicación móvil y la báscula se conectarán de manera automática cada vez que abra la aplicación.

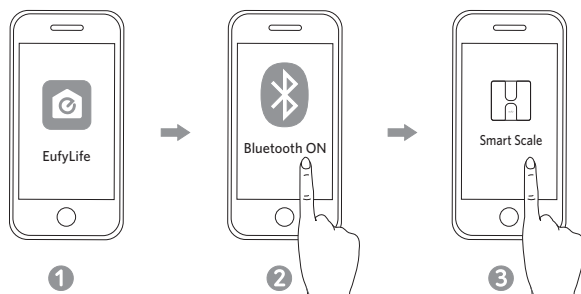

	Ícono de estado	Significado
	Parpadeando	Sincronización en proceso
	Estática	Dispositivos sincronizados



- La báscula es compatible con dispositivos que operen con iOS 8.0 o superior y Android 4.3 o superior.
- No sincronice la báscula desde el menú de sincronización de Bluetooth de su aparato móvil. Solo utilice la aplicación móvil EufyLife para sincronizar ambos dispositivos.

Primer registro de medidas

Antes de realizar sus primeras mediciones, deberá crear y configurar una cuenta de usuario en la aplicación móvil EufyLife. Es posible crear hasta 16 cuentas de usuario.

- 1 Posicione la báscula en una superficie plana y firme.
- 2 Abra la aplicación móvil EufyLife y seleccione Báscula Inteligente en la página principal del dispositivo.
- 3 Suba a la báscula con los pies descalzos. De manera automática, se iniciará un análisis de su composición corporal.



Ubíquese al centro de la báscula con los pies descalzos. Permanezca inmóvil y asegúrese que los electrodos hagan contacto con sus pies en todo momento hasta que finalice la medición.

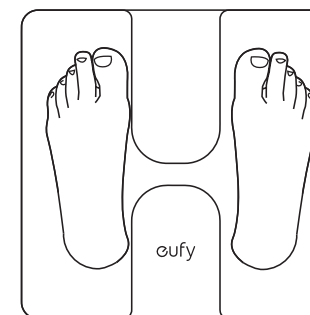

Medir solo su peso

Esta báscula también puede ser utilizada para leer su peso de la misma manera que lo haría con una báscula convencional. Simplemente suba a la báscula para tomar su peso, sin abrir la aplicación móvil EufyLife.

Mantenimiento

Limpie la báscula con regularidad, utilizando un paño suave y seco o levemente humedecido.



- No lave la báscula con agua ni la sumerja en agua.
- Jamás use detergentes para limpiar la báscula, ya que podría decolorarla o provocarle daños que conlleven al mal funcionamiento del dispositivo.

Solución de problemas

Mensajes de error

Error mostrado	Description	Solution
OL	Sobrecarga. El dispositivo se apagará automáticamente.	Deje de utilizar la báscula para mediciones.
Lo	Batería baja. El dispositivo se apagará automáticamente.	Sustituya las tres pilas al mismo tiempo.
Err	Fallas en registro de mediciones.	<ul style="list-style-type: none"> • Suba con pies descalzos a la báscula y asegúrese que los electrodos hagan contacto con sus pies en todo momento. • Permanezca inmóvil en la báscula hasta que las medidas queden fijadas en el visor LED.

Toma de medidas

Situación	Causa	Solución
Anomalías en proceso de medición: <ul style="list-style-type: none"> • Muy alto • Muy bajo • Diferencia significativa en ambas mediciones 	<ul style="list-style-type: none"> • Postura incorrecta. • El dispositivo se encuentra en una superficie suave o irregular. 	<p>Suba a la báscula con pies descalzos y permanezca inmóvil.</p> <p>Coloque el dispositivo en una superficie plana y firme.</p>
Visor LED no enciende al subir a la báscula.	<ul style="list-style-type: none"> • Pilas no instaladas. • Agotamiento de pilas. 	<ul style="list-style-type: none"> • Instale tres pilas nuevas. • Sustituya las tres pilas al mismo tiempo.
La báscula no analiza mi masa corporal.	<ul style="list-style-type: none"> • Tomarse mediciones con zapatos o calcetines puestos. 	<ul style="list-style-type: none"> • Suba a la balanza con pies descalzos y asegúrese que los electrodos hagan contacto con sus pies en todo momento.

Especificaciones técnicas

Modelo de producto	T9146
Voltaje de funcionamiento	4.5 V (3 × pilas AAA)
Visor LED	67 × 29 mm / 2.6 × 1.2 in
Unidades de medida	Libras / Kilogramos
Unidades de incremento	0.1 lb / 0.1 kg
Unidades de incremento en porcentaje de grasa corporal	0.1 %
Unidades de incremento en porcentaje de agua corporal	0.1 %
Unidades de incremento en porcentaje de masa muscular	0.1 %
Rangos de medición	11-397 lb / 5-180 kg
Condiciones ambientales para funcionamiento apropiado	Temperatura: 5 - 40 °C Humedad: 20 - 90% RH
Condiciones ambientales apropiadas para almacenaje	Temperatura: -20 - 50 °C Humedad: <= 90% RH
Dimensiones	280 × 280 × 23 mm / 11.0 × 11.0 × 0.9 in
Peso neto	3.31 lb / 1.5 kg

Servicio al Cliente

 Garantía limitada de 15 meses

 Asistencia técnica de por vida

 support@eufylife.com

 (US) +1 (800) 988 7973 Mon - Fri 9:00am - 5:00pm (PT)
 (UK) +44 (0) 1604 936200 Mon - Fri 6:00 - 11:00 (GMT)
 (DE) +49 (0) 69 9579 7960 Mo - Fr 6:00 - 11:00
 (中国) +86 400 0550 036 周一至周五 9:00 - 17:30
 (日本) +81 03 4455 7823 月 - 金 9:00 - 17:00

 @EufyOfficial

 @EufyOfficial

 @EufyOfficial

 @EufyOfficial

Ce qu'il y a dans la boîte

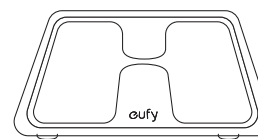

Smart Scale C1

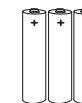

AAA piles (×3)



Manuel de l'utilisateur et
Guide de démarrage rapide

Inserion des piles

- 1 Retournez la balance et placez-la sur une surface plane.
- 2 Ouvrir le couvercle des piles et insérer trois piles AAA. Assurez-vous que les extrémités positive et négative sont tournées vers les bonnes directions de polarité marquées dans le compartiment des piles.
- Les chiffres "8888" s'afficheront sur l'écran LED.
- 3 Fermez le compartiment et attendez que les chiffres "00" s'affichent sur l'écran LED.

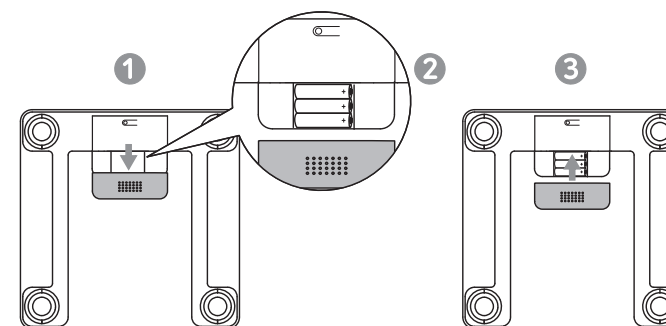

LO apparaîtra sur l'écran LED lorsque les piles sont faibles. Remplacez
Remplacer les trois piles en même temps. Ne pas mélanger des piles
nouvelles et usages.

Sélection de l'unité de mesure

Appuyez sur le bouton **Unit** en bas de la balance pour parcourir et sélectionner l'unité de mesure : **lb** (Livre) / **kg** (Kilogramme). L'unité de mesure peut également être sélectionnée dans l'application.

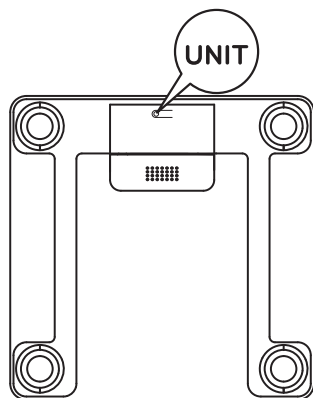

Installation et Appairage de l'application

- 1 Téléchargez l'application EufyLife depuis l'App Store (appareils iOS) ou Google Play (appareils Android).
- 2 Activez le Bluetooth sur votre smartphone ou tablette.
- 3 Ouvrez l'application EufyApp et suivez les instructions à l'écran pour appairer la balance à votre appareil.
 - Une fois appairés, l'application et la balance se reconnecteront automatiquement la prochaine fois que l'application est ouverte.

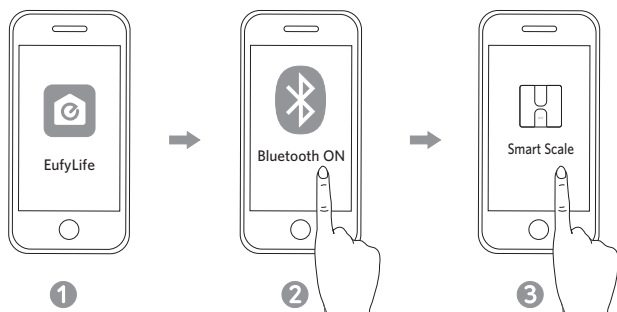

	Icône d'état	Indique
	Cignotante	Appairage en cours
	Fixe	Appairage réussi



- Cette balance est compatible avec les appareils sous iOS 8.0 et versions supérieures ou sous Android 4.3 et versions supérieures.
 - N'appairez pas la balance à partir du menu Bluetooth de votre smartphone, mais utilisez l'application EufyLife.

Démarrage d'une mesure

Avant de prendre votre première mesure, vous devrez créer et configurer un compte utilisateur sur l'application EufyLife. Il est possible de créer jusqu'à 16 comptes.

- 1 Placez la balance sur une surface plane et dure.
- 2 Ouvrez l'application EufyApp et suivez les instructions à l'écran pour appairer la balance à votre appareil.
- 3 Montez pieds nus sur la balance. Une analyse de la composition de votre corps commencera automatiquement.



placez vos pieds nus sur le centre de la balance. Restez immobile et gardez un contact complet avec les électrodes jusqu'à ce que la mesure soit complète.

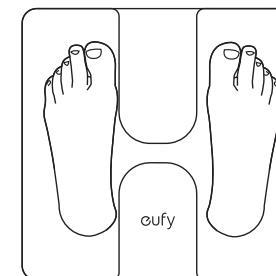

Mesure du poids uniquement

Cette balance peut également être utilisée comme une balance de lecture de poids classique. Vous pouvez simplement monter sur la balance pour mesurer votre poids, sans ouvrir l'application EufyLife.

Maintenance

Nettoyez régulièrement la balance avec un chiffon doux sec ou légèrement humide.

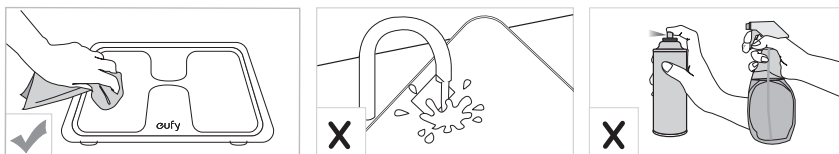

- Ne nettoyez pas la balance avec de l'eau et ne l'immergez pas dans l'eau.
- N'utilisez jamais de détergent pour nettoyer la balance, cela pourrait provoquer un dysfonctionnement ou une décoloration.

Troubleshooting

Message d'erreur

Ecran	Description	Solution
OL	Surcharge. L'appareil va s'éteindre.	Arrêtez d'utiliser cette balance.
Lo	Batterie faible. L'appareil va s'éteindre.	Remplacer les trois piles en même temps.
Err	Echec de la mesure.	<ul style="list-style-type: none"> • Montez pieds nus sur la balance et restez en contact constant avec ses électrodes. • Tenez-vous immobile jusqu'à ce que la mesure indiquée sur l'écran LED se bloque.

Pendant la prise de mesure

Problème	Cause	Solution
Résultats de mesure anormaux : <ul style="list-style-type: none"> • Trop hauts • Trop bas • Grande différence entre deux mesures récentes 	<ul style="list-style-type: none"> • Position incorrecte. • L'appareil est placé sur un tapis moelleux ou une surface irrégulière. 	<ul style="list-style-type: none"> Montez sur la balance pieds nus et restez immobile. Placez l'appareil sur une surface dure et plane.
L'écran LED ne s'allume pas après être monté sur la balance.	<ul style="list-style-type: none"> • Piles non installées. • Piles usées. 	<ul style="list-style-type: none"> • Installer trois nouvelles piles. • Remplacer les trois piles en même temps.
La balance ne procède pas à l'analyse de la composition corporelle.	<ul style="list-style-type: none"> • Mesure effectuée en portant des chaussures ou des chaussettes. 	<ul style="list-style-type: none"> • Montez pieds nus sur la balance et restez en contact constant avec ses électrodes.

Spécifications

Modèle	T9146
Puissance	4.5 V (3 x piles AAA)
Ecran LED	67 × 29 mm / 2.6 × 1.2 in
Unités de mesure	Livre / Kilogramme
Incréments unitaires	0.1 kg / 0.1 lb
Incréments unitaires de la masse grasse	0.1 %
Incréments unitaires de la masse d'eau corporelle	0.1 %
Incréments unitaires de la masse musculaire	0.1 %
Plage de mesure	11-397 lb / 5-180 kg
Environnement de travail	Température : 5 - 40 °C Humidité : 20 - 90% RH
Environnement de conservation	Température : -20 - 50 °C Humidité : ≤ 90% RH
Fréquence de fonctionnement	2402-2480 MHz
Puissance de la fréquence radio	4 dBm
Dimensions	280 × 280 × 23 mm / 11.0 × 11.0 × 0.9 in
Poids net	3.31 lb / 1.5 kg

Service client

 Garantie limitée 15 mois

 Support technique à vie

 support@eufylife.com

 (US) +1 (800) 988 7973 Mon - Fri 9:00am - 5:00pm (PT)
 (UK) +44 (0) 1604 936200 Mon - Fri 6:00 - 11:00 (GMT)
 (DE) +49 (0) 69 9579 7960 Mo - Fr 6:00 - 11:00
 (中国) +86 400 0550 036 周一至周五 9:00 - 17:30
 (日本) +81 03 4455 7823 月 - 金 9:00 - 17:00

 @EufyOfficial

 @EufyOfficial

 @EufyOfficial

 @EufyOfficial

Contenuto della Confezione

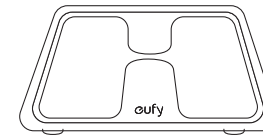

Bilancia Smart C1



AAA Batterie (×3)



Manuale d'uso e
Guida di avvio rapido

Inserire le Batterie

- 1 Capovolgere la bilancia e riporla su una superficie piana.
- 2 Aprire il vano batteria e inserire le tre batterie AAA. Assicurarsi che le batterie siano posizionate secondo la corretta polarità indicata nel comparto.
- Le cifre "8888" appariranno sul display LED.
- 3 Chiudere il vano per le batterie e attendere che le cifre "00" appaiano sul display LED.

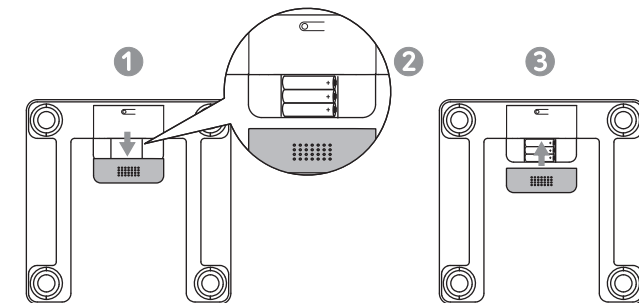

LO apparirà sul display LED quando le batterie sono scariche.
Sostituire tutte e tre le batterie nello stesso momento. Non combinare batterie nuove e usate.

Selezionare l'Unità di Misura

Premere il tasto **Unità** sul fondo della bilancia per selezionare le varie unità di misura. **lb** (Libbre) / **kg** (Chilogrammi). L'unità di misura può essere selezionata anche dall'App.

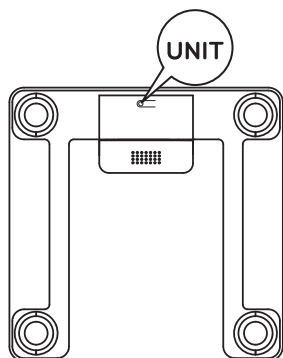

Installazione dell'App EufyLife e Sincronizzazione

- 1 Scaricare l'App EufyLife dall'App Store (dispositivi iOS) o Google Play (dispositivi Android).
- 2 Attivare il Bluetooth sul vostro smartphone o tablet.
- 3 Aprire l'App EufyLife e seguire le istruzioni su schermo per sincronizzare la bilancia con il vostro dispositivo.
 - Una volta accoppiati, l'App e la bilancia si conetteranno automaticamente quando l'App sarà avviata la volta successiva.

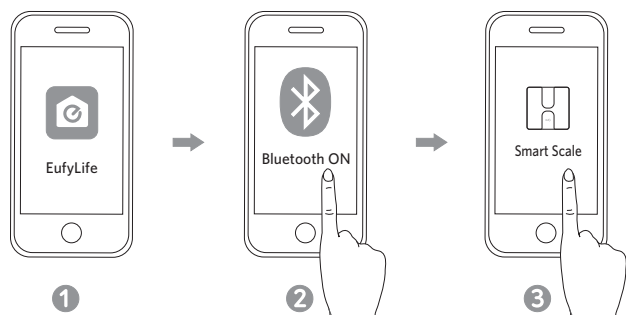

	Icone di Stato	Indicazione
	Lampeggiante	Accoppiamento
	Fissa	Connessa



- Questa bilancia è compatibile con dispositivi con iOS 8.0 e superiore o Android 4.3 e superiore.
- Non sincronizzare la bilancia dal menù bluetooth del vostro smartphone. Utilizzare l'App EufyLife per farlo.

Iniziare la Misurazione

Prima di effettuare la prima misurazione sarà necessario creare e impostare un profilo utente nell'App EufyLife. È possibile creare fino a 16 profili utente.

- 1 Posizionare la bilancia su una superficie liscia e dura.
- 2 Avviare l'App EufyLife e selezionare Bilancia Intelligente sulla pagina principale.
- 3 Salire a piedi nudi sulla bilancia. L'analisi della composizione del vostro corpo inizierà automaticamente.



- Salire al centro della bilancia a piedi nudi. Restare fermi e mantenere pieno contatto con gli elettrodi fino a quando la misurazione non sarà completa.*

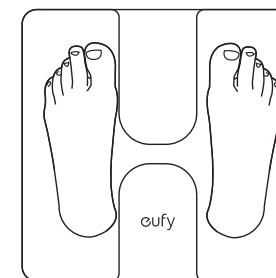

Misurare solo il Peso Corporeo

La bilancia può essere utilizzata anche in maniera convenzionale per indicare solo il peso corporeo. Basta salire sulla bilancia per misurare il proprio peso senza avviare l'App Eufylife.

Manutenzione

Pulire la bilancia regolarmente con un panno asciutto o leggermente umido



- Non lavare la bilancia con acqua e non immergerla in acqua.
- Non utilizzare detergenti per pulire la bilancia in quanto ciò potrebbe causare malfunzionamento o macchie sulla superficie.

Soluzione dei Problemi

Messaggio di Errore

Messaggio su Display	Descrizione	Soluzione
OL	Sovraccarico. Il dispositivo si spegnerà.	Smettere di utilizzare la bilancia per la misurazione.
Lo	Batterie scariche. Il dispositivo si spegnerà.	Sostituire tutte e tre le batterie nello stesso momento.
Err	Errore durante la misurazione.	<ul style="list-style-type: none"> • Salire a piedi nudi e mantenere pieno contatto con gli elettrodi. • Restare fermi fino a quando la misurazione sul display LED si stabilizza.

Durante la Misurazione

Problema	Causa	Soluzione
Anomalia nei risultati: <ul style="list-style-type: none"> • Troppo alti • Troppo bassi • Grande differenza tra i due risultati più recenti 	<ul style="list-style-type: none"> • Postura errata. • Il dispositivo è posizionato su superficie soffice come tappeto o su superficie irregolare. 	Salire sulla bilancia a piedi nudi e restare fermi. Posizionare il dispositivo su una superficie liscia e dura.
Il display LED non si accende dopo essere saliti sulla bilancia.	<ul style="list-style-type: none"> • Batterie non installate. • Batterie consumate. 	<ul style="list-style-type: none"> • Installare tre nuove batterie. • Sostituire tutte e tre le batterie nello stesso momento.
La bilancia non effettua l'analisi della composizione del corpo.	<ul style="list-style-type: none"> • Misurazione effettuata indossando scarpe o calze. 	<ul style="list-style-type: none"> • Salire a piedi nudi sulla bilancia assicurando un pieno contatto con gli elettrodi durante la misurazione.

Specifiche

Modello	T9146
Potenza	4.5 V (3 x Batterie AAA)
Display LED	67 x 29 mm
Unità di Misura	Chilogrammi / Libbre
Sensibilità	0.1 kg / 0.1 lb
Incremento Unità per Grasso Corporeo	0.1 %
Incremento Unità per Contenuto di Acqua nel Corpo	0.1 %
Incremento Unità per Massa Muscolare	0.1 %
Intervallo di Misura	11-397 lb / 5-180 kg
Ambiente di Lavoro	Temperatura: 5 - 40 °C Umidità: 20 - 90% RH
Ambiente di Conservazione	Temperatura: -20 - 50 °C Umidità: <= 90% RH
Gamma di frequenze operativa	2402--2480 MHz
Potenza della frequenza radio	4 dBm
Dimensioni	280 x 280 x 23 mm
Peso Netto	1.5 kg

Servizio clienti

 Garanzia limitata 15 mesi

 Supporto a vita

 support@eufylife.com

 (US) +1 (800) 988 7973 Mon - Fri 9:00am - 5:00pm (PT)
(UK) +44 (0) 1604 936200 Mon - Fri 6:00 - 11:00 (GMT)
(DE) +49 (0) 69 9579 7960 Mo - Fr 6:00 - 11:00
(中国) +86 400 0550 036 周一至周五 9:00 - 17:30
(日本) +81 03 4455 7823 月 - 金 9:00 - 17:00

 @EufyOfficial

 @EufyOfficial

 @EufyOfficial

 @EufyOfficial

